

3Pack and 6Pack

Portable Dimmer Packs

User's Manual



The material in this document is for information purposes only and is subject to change without notice. Strand Lighting assumes no responsibility for any errors or omissions which may appear in this manual. For comments and suggestions regarding corrections and/or updates to this manual, please contact your nearest Strand Lighting office.

El contenido de este manual es solamente para información y está sujeto a cambios sin previo aviso. Strand Lighting no asume responsabilidad por errores o omisiones que puedan aparecer. Cualquier comentario, sugerencia o corrección con respecto a este manual, favor de dirigirlo a la oficina de Strand Lighting más cercana.

Der Inhalt dieses Handbuches ist nur für Informationszwecke gedacht, Aenderungen sind vorbehalten. Strand Lighting uebernimmt keine Verantwortung für Fehler oder Irrtuemer, die in diesem Handbuch auftreten. Für Bemerkungen und Verbesserungsvorschlaege oder Vorschlaege in Bezug auf Korrekturen und/oder Aktualisierungen in diesem Handbuch, moechten wir Sie bitten, Kontakt mit der naechsten Strand Lighting-Niederlassung aufzunehmen.

Le matériel décrit dans ce manuel est pour information seulement et est sujet à changements sans préavis. La compagnie Strand Lighting n'assume aucune responsabilité sur toute erreur ou ommission inscrite dans ce manuel. Pour tout commentaire ou suggestion concernant des corrections et/ou les mises à jour de ce manuel, veuillez contacter le bureau de Strand Lighting le plus proche.

Table of content

Introduction	4
Specifications	4
Installation	5
Installation Notes	5
Mains Power Input Connections	6
Mains Cable Entry	6
Rear Cable Entry	7
Side Cable Entry	7
Mains Cable Termination	7
Protection	8
Power Distribution	8
Wall Mounting	9
Control Input	9
Data cable termination	10
Dimmer Outputs	10
Service and Maintenance	11
Safety Tests	11
Dimmer Load Test Facility	11
Set up	12
Set Dimmer Level	13
Select Preset 0-9	13
Patch	14
Set Curves	16
Minimum Level	17
Maximum Level	18
DMX Fail	19

Introduction

Strand Lighting **3Pack/6Pack** dimmer packs are compact, portable-dimming units, designed for use in conjunction with lighting control console.

The basic **3Pack/6Pack** accepts standard DMX 512 multiplexed digital control input

Specifications

Power Requirements

Voltage: 200 - 260 Volts AC. Frequency: 50 - 60 Hz.

Three phase + Neutral + Earth

3Pack/6Pack dimmer packs must be Earthed for safety in use.

Dimming Capacity

3Pack

Each pack contains three dimmers with one socket outlet per dimmer.

Maximum load 5kW per dimmer - total 15kW per dimmer pack.

6Pack

Each pack contains six dimmers with two socket outlets per dimmer.

Maximum load 2.3kW per dimmer - total 13.8kW per dimmer pack.

Dimmer Output Connections

3Pack

3Pack is available with a CEE17 socket outlet per dimmer.

6Pack

6packs are available with a variety of socket outlets to suit different operating conditions and national standards. A version without sockets is also available. This version includes a removable panel which maybe used for mounting outlets of any suitable type.

Two sockets per dimmer are fitted as standard.

Control Inputs

USITT DMX512(1990) multiplexed digital control, via 5 pin XLR connector.

Physical Dimensions (unpacked)

Height: 178 mm.

Width: 483 mm.

Depth: 250 mm.

Weight: 14Kg (approximately)

Environment (Operating)

Temperature: 0°C - 37°C.

Relative humidity: 0% - 90%.

Condensation level: Zero.

3Pack/6Pack are suitable only for use in a dry, internal environment.

Protection Classification

IP30.

Equipment Class

Class 1.

Installation

WARNING

Hazardous voltages are present in 3Pack/6Pack. Ensure that the mains supply is isolated before opening the equipment for installation or servicing.

Dimmer packs should be installed and serviced only by suitably competent (Electrical) personnel.

3Pack and 6Pack may be installed in three manners:

As free standing units (for temporary installations),

Mounted on a wall (for permanent installations) – refer also to pages 6,7 and 9,

Several packs mounted together in a rack (for hire or touring purposes).

Installation Notes

In order to enhance the reliability of the dimmers, it is recommended that they are operated within the following environmental limits:

Temperature: 18°C - 25°

Relative Humidity: 60% - 80%

Condensation level: Zero

3Pack and 6Pack dimmers are designed such that Earth leakage currents are minimised, allowing their use on mains power supplies protected by 30mA Residual Current Devices. However, utilising RCD protection in dimming installations may present problems. Please contact Strand Lighting for specific advice

The dimmers may emit a slight buzzing noise when in operation. They should be installed away from areas where such noise would be undesirable.

The physical dimensions of a 6Pack dimmer pack are shown in Figure 1. The dimensions of a 3Pack dimmer pack are identical.

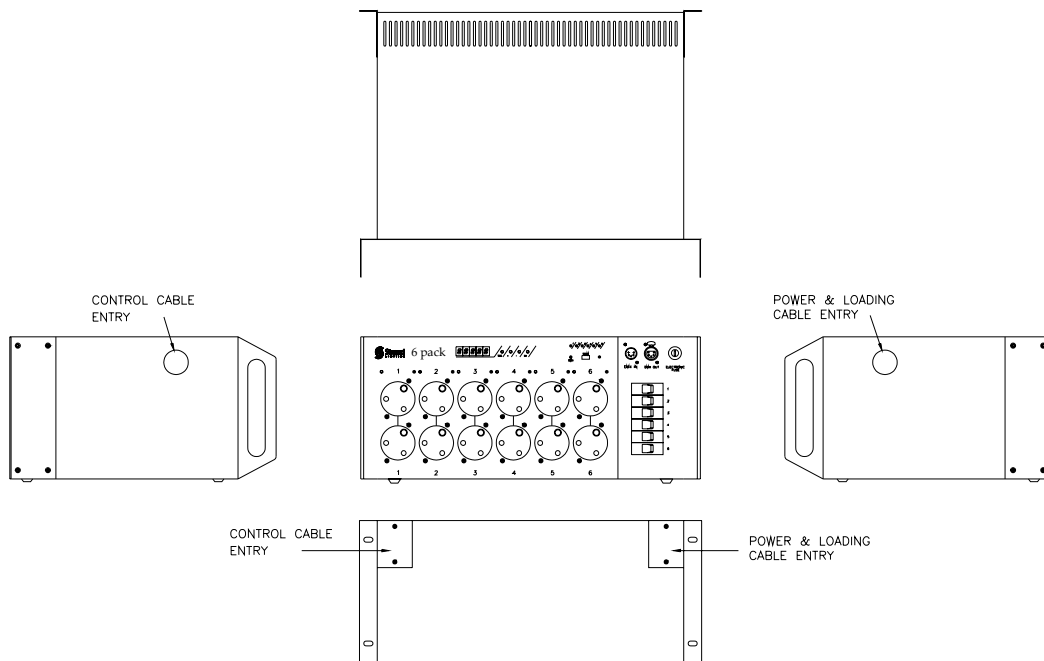

Figure 1

Mains Power Input Connections

3Pack and 6Pack dimmer packs require a nominal mains input at 230V 50Hz AC. This supply may be either single or three phase (star only), depending on the method of connection. In either case separate Neutral and Earth conductors are required.

WARNING

3Pack and 6Pack dimmer packs must be Earthed for safety in operation.

The Neutral conductor must have the same (or greater) cross-sectional area, as the Phase conductor(s). (Triac and thyristor dimmers operate using 'phase control'. This renders the 'balancing' of loads across phases - and thus a reduction in Neutral currents impossible)

*3Pack and 6Pack dimmer packs should be connected to their mains supplies via adequately rated cable, together with any associated plug and socket connectors. For full power operation the supply must be rated at 60A for single phase operation, 20A for three phase operation. These ratings may be reduced if the supply protective devices are selected to limit the current drawn to appropriate limits. Should supply diversity be applied care is required in the sizing of supply neutral conductors. If in doubt please seek advice from Strand Lighting.
For safety in operation each rack must be fed from an appropriately fused supply.*

It is strongly recommended that the mains supply to the dimmers is taken via a local isolating switch, so that the supply may be easily disconnected for plugging and unplugging of load connectors and for service or maintenance.

All cables, switchgear and protection equipment must be selected and installed in accordance with locally prevailing electrical regulations.

Mains Cable Entry

The mains input cable will enter the pack either via a Rear Connection Panel, or via one of the Side Plates – depending on the manner in which the pack is to be mounted:

For wall mounting, side cable entry must be used,

For rack mounting, rear cable entry must be used,

For free standing, either side or rear cable entry may be used, although the rear cable entry is recommended.

Rear Cable Entry

Remove the Rear Connection Panel. It is secured to the base by two screws, as shown in Figure 2.

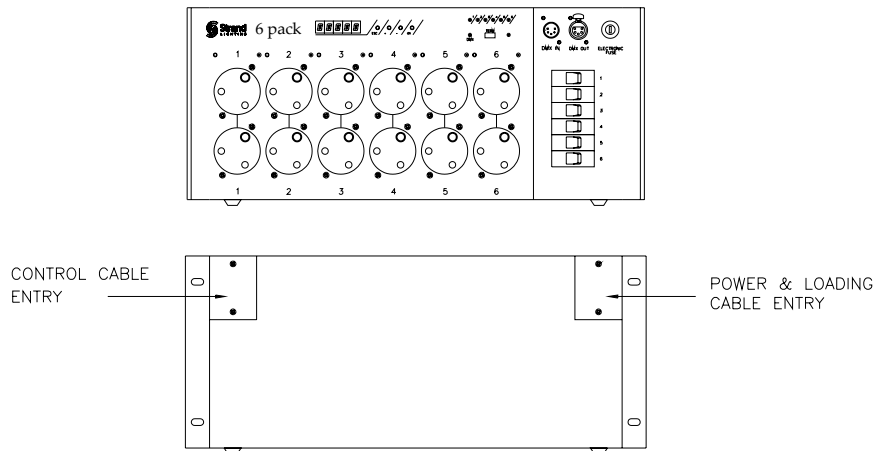

Figure 2

Side Cable Entry

Remove the selected Side Plate as indicated in Figure 3

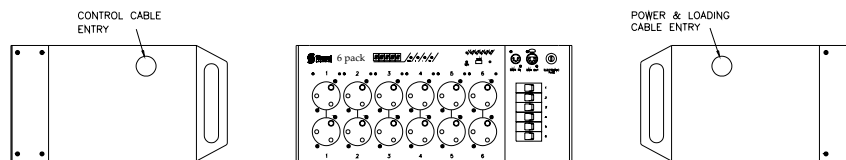

Figure 3

A 32mm diameter cable entry hole is provided in each Side Plate. Remove the blanking plug from its hole, and fit a cable gland of the correct size.

Mains Cable Termination

The mains input is connected at a set of screw terminal blocks, situated inside the pack, at the right hand side (looking from the front of the pack). The terminals will accept cables of up to 16 mm² in size. If it is required to connect a 3Pack or 6Pack to a single phase supply, the link bar supplied with the pack should be used to join the three phase terminals together, as follows (refer to right-hand diagram in Figure 4):

1. Loosen all three phase terminals.
2. Place incoming cable inside terminals and tighten securely.

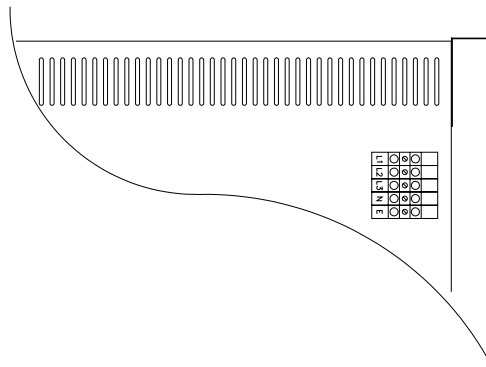

Figure 4 Mains Termination

WARNING

Do NOT fit the link bar when the pack is connected to a three phase supply

Protection

The mains supply to each dimmer pack must be protected against external overload. Appropriate fuse or circuit breaker ratings are 60A for single phase supply and 20A for a three phase supply. If the available mains supply is not capable of providing the full rated currents, the protection device rating must be reduced accordingly; it will not be possible to use the dimmers with their maximum rated loads.

Protection systems on the supply to each dimmer pack should limit the potential fault current level to 1500A or less.

Power Distribution

To achieve correct Earthing and mains power distribution, it is recommended that all dimmers and lighting control equipment within the installation should draw mains power from one central distribution point. This should be as close as possible to the mains power intake for the site or building. The wiring from the distribution point to the lighting equipment should ideally be used for supplying power to the lighting equipment alone, and not to other appliances or equipment.

3Pack and **6Pack** must be properly Earthed, both for safety and to ensure correct operation.

It is essential that all Earth connections within the overall installation are at comparable potentials. If this is not the case, circulating currents may be generated in signal earth connections, possibly leading to fluctuating light levels and (in some extreme cases) damage to wiring or equipment.

Care should be taken when differing electrical supplies (for example local generation for dimmers, public mains for control console) are in use or internal mains power distribution is TN-C (combined neutral & earth conductors)

If in doubt, as to the nature of your local electrical supply arrangements please seek advice from an authoritative person at your site..

Wall Mounting

The 3Pack/6Pack dimmer pack is designed for wall mounting. To prevent overheating of wall-mounted dimmers when in use, locate the feet of an upper rack for racks to be directly stood on top of each other as shown in Figure 5. Do not block the ventilation holes situated on the sides and top of the dimmer pack.

The unit is supplied with fixing brackets for wall mounting applications. Care should be taken to adequately secure the unit to any surface to which it is mounted and that the surface is suitable for this application.

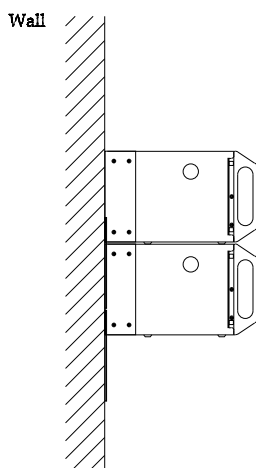

Figure 5

WARNING

Forced ventilation is advised if racks are mounted within a flight case or similar closely constraining enclosure.

Control Input

The 3Pack/6Pack accepts DMX512 control inputs:

DMX512

The DMX512 input will accept a multiplexed digital control signal which conforms to USITT specification DMX512 (1990). Details of this specification are available from USITT on request.

The DMX control input is via a five-pin male XLR type connector. Pin connections are shown in Figure 6. A five-pin female XLR connector is also fitted to allow a series of 3Pack/6Pack dimmer packs (or other DMX equipment) to be daisy chained together.

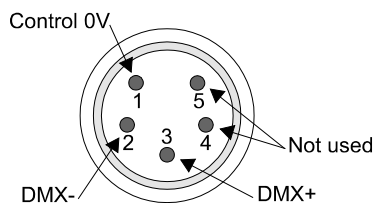

View of front
of dimmer unit

Figure 6

Data cable termination

When required, data cables can be terminated directly to the termination blocks provided inside the 3Pack/6Pack. The internal data cable termination positions are as shown in Figure 7.

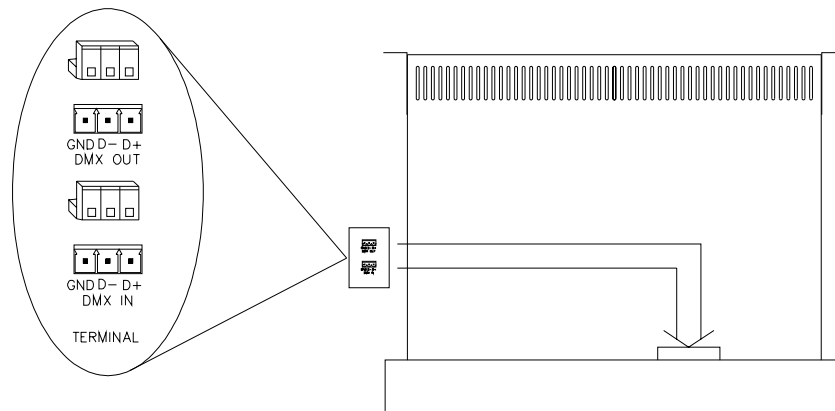

Control Cables Assignment (Internal)

Figure 7

Dimmer Outputs

6Pack

Dimmer output connections are by means of socket outlets on all styles of 6Pack dimmer packs, except the terminal strip version. Two sockets are fitted per dimmer.

When operating from a three phase supply, dimmers 1 and 2 are connected to phase 1, dimmers 3 and 4 to phase 2, and dimmers 5 and 6 to phase 3.

Plug tops used for dimmer output connections must be of the correct type to match the socket outlets.

It is important that plugs are wired correctly. Figure 8 shows the various types of socket outlets fitted to 6Pack dimmer packs.

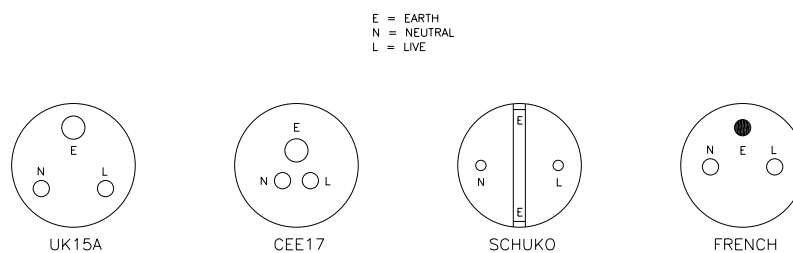

Figure 8

3Pack

Dimmer output connections on 3pack are by means of a single CEE17 socket outlet per dimmer. Connections are as shown for CEE17 in Figure 8.

When operating from a three phase supply, dimmer 1 is connected to phase 1, dimmer 2 to phase 2, and dimmer 3 to phase 3.

Service and Maintenance

3Pack/6Pack dimmer packs do not require routine maintenance other than external cleaning. However, in common with all electrical equipment, they should be periodically checked to ensure that they remain in good condition. Any repairs or maintenance to the internal electronics, or other circuitry, should be carried out only by authorised Strand Lighting Service personnel or approved Service Providers.

Safety Tests

3Pack/6Pack dimmer packs are subjected to safety inspections and tests prior to despatch from the Strand Lighting factory.

If, as part of routine maintenance, the packs are to be subjected to electrical safety tests applied using a 'standard' Portable Appliance Tester, the following points should be observed:

The nature of the electronic dimmer circuits means that an 'insulation test' using a voltage in the order of 500V will give a result of approximately 1.7MΩ. Although this may *appear* as a test failure, the apparently low resistance is normal for these dimmer packs and is *not* due to failing insulation. **User safety is not at risk.**

Caution

A high voltage 'Flash' test must not be applied to an 3Pack/6Pack dimmer pack.

A high current Earth continuity test must not be applied to the signal ground pins of the control input connector(s).

Dimmer Load Test Facility

To test the basic operation of any dimmer, press the Test button. This will switch the dimmer to full on. The switch operates in a push-on, push-off manner.

The Test LED indicator illuminates to show that the switch is ON.

Set up

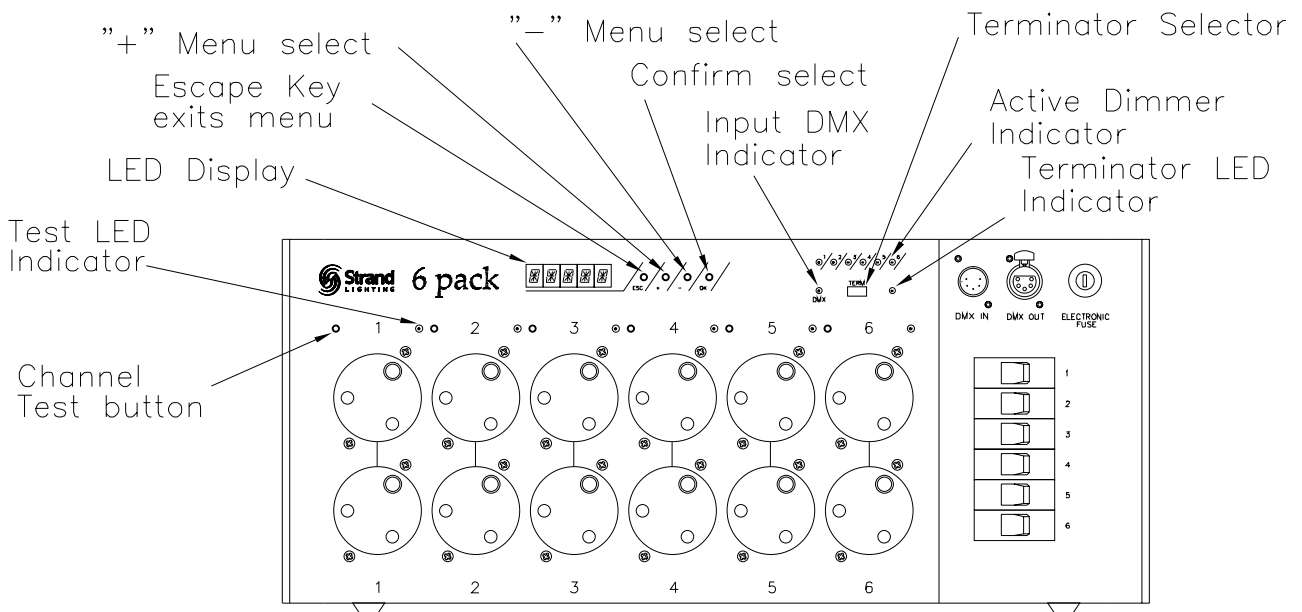

Figure 9 Set up keys and displays

The **3Pack/6Pack** dimmer pack offers a selection of set up and configuration features that are accessed from the front panel using the four set up keys and LED Display. Menu and setting selections are made with the + and - keys. To exit any menu press the ESC (escape) key and OK is the confirmation key.

At the top level of the menu with the display of **3Pack** or **6Pack**, press +/- to navigate from Set Dimmer Level, Preset, Patch, Curve, Minimum Level, Maximum Level and DMX fail. Press OK to enter into any of that specific menu.

KEYLOCK

Lock by holding [ESC] and [OK] for 3 seconds (5th digit dot is ON). Repeat to unlock.

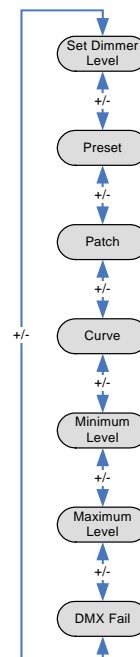

Set Dimmer Level

When a control console is not available, the dimmer levels on **3Pack/6Pack** dimmer systems can be individually set to a desired level using the front panel keys. After the selection of +/- key to the Set Level display, press OK to enter into the Set Level.

Set all Dimmer Levels

Use “+” or “-” to change the display to ALL, OK to confirm setting all dimmer levels. Default is all at Input, press +/- to select dimmer levels follow by OK.

Set single Dimmer Level

Use +/- to select channel 1-6, OK to confirm setting of that particular channel. Default is input, press +/- to select the dimmer level of that channel follow by OK.

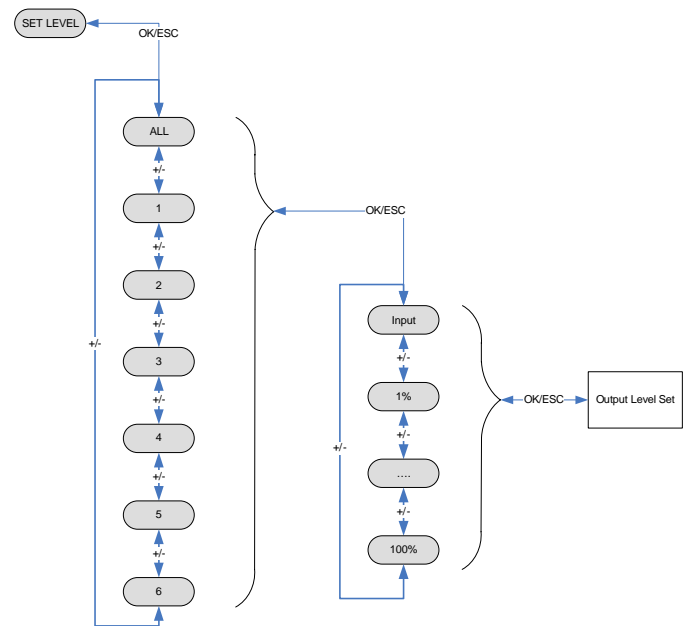

Select Preset 0-9

This menu is to set the content of a Preset in the range from Preset 0 to Preset 9. The preset can be called up during DMX fail.

Use +/- to select Preset number, OK to confirm and press +/- to select snaps/edit follows by OK.

Snaps

Snaps is to take a snap shot from the DMX input, when the snaps display on the LED window, press OK to take the DMX level from the DMX input.

Edit

Edit to change individual channels within the Preset. Similar to Set Level, you can use all or individual channel to edit a certain Preset.

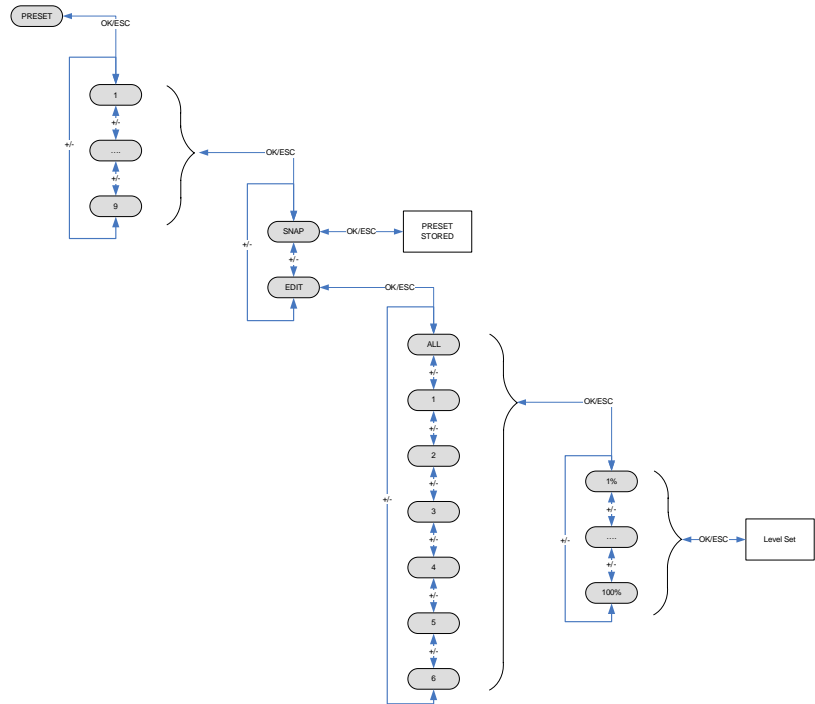

Patch

This menu is to set either the DMX start address if the dimmer channels are used sequentially or each DMX address can be patched individually to each dimmer channel.

Use +/- keys to select either “DMX Address Start” or “DMX Address independent” menu.

Select Start DMX address

When in the “DMX Address Start” menu, press the **OK** key once, the start address is now displayed. Use the **+** and **-** keys to select the start address (1 – 512) for the dimmer pack. When complete, press **OK** key to confirm.

Set independent dimmer patch

When in “DMX Address Independent” menu, press the **OK** key once, the dimmer Channel # is now displayed on the LED, Use the **+** and **-** keys to select the dimmer channel (1 – 6) and then press the **OK** key again. Use the **+** and **-** keys to select the DMX address (1 – 512) to be assigned to the dimmer channel. After selecting the DMX address, press the **OK** key and the selected patch will be recorded. Repeat the above process until all channels are set.

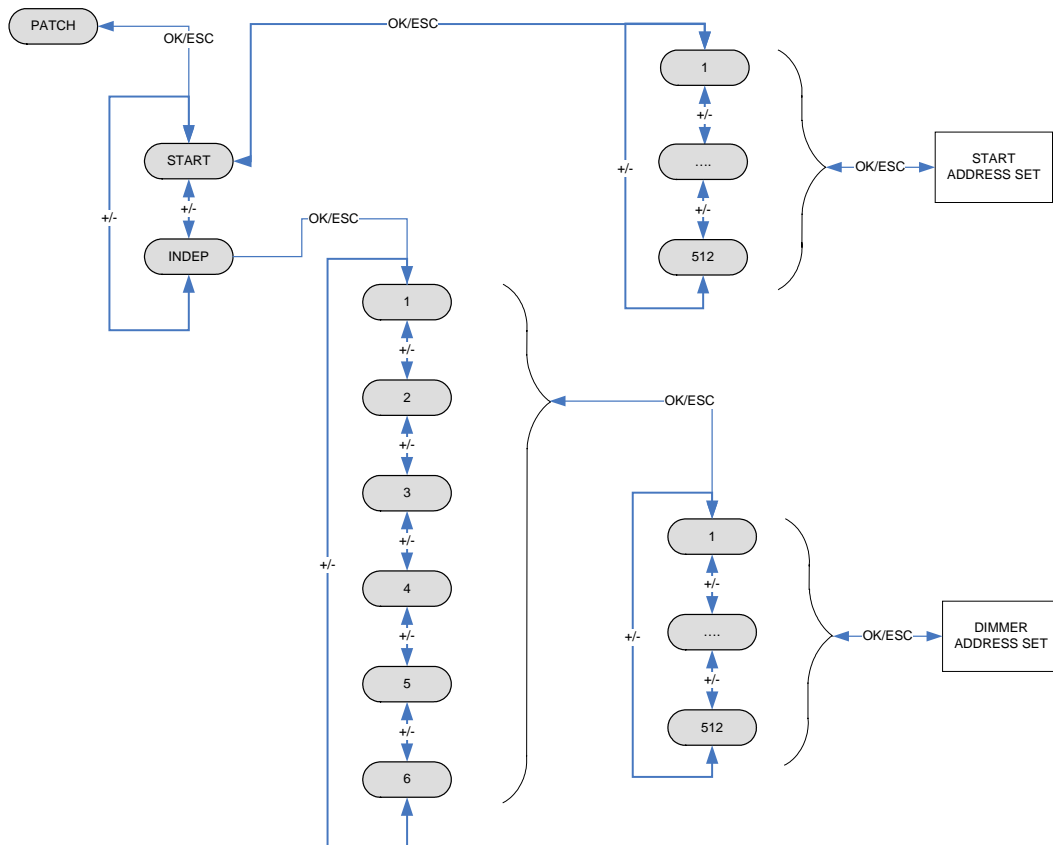

Set Curves

This menu is used to select a dimmer curve for any or all the dimmers in a system. There are three dimmer curves available to choose from Linear, Non-Dim and Square law. When the Curve menu is shown after pressing the **OK** key, use the **+** and **-** keys to select either the “Curve All” menu for all dimmers or the “Curve Independent” menu for a single dimmer.

Set Curve for all Dimmers

When in the “Curve All” menu, press the **OK** key once, then use the **+** and **-** keys to select one of the three curves.

Set Curve for Single Channel

When in the “Curve Independent” menu, press the **OK** key once, the dimmer Channel # will be displayed, use the **+** and **-** keys to select the dimmer channel (1 – 6) to be set. Press the **OK** key again followed by the **+** and **-** keys to select the preferred curve. Repeat the above process until all channels are set.

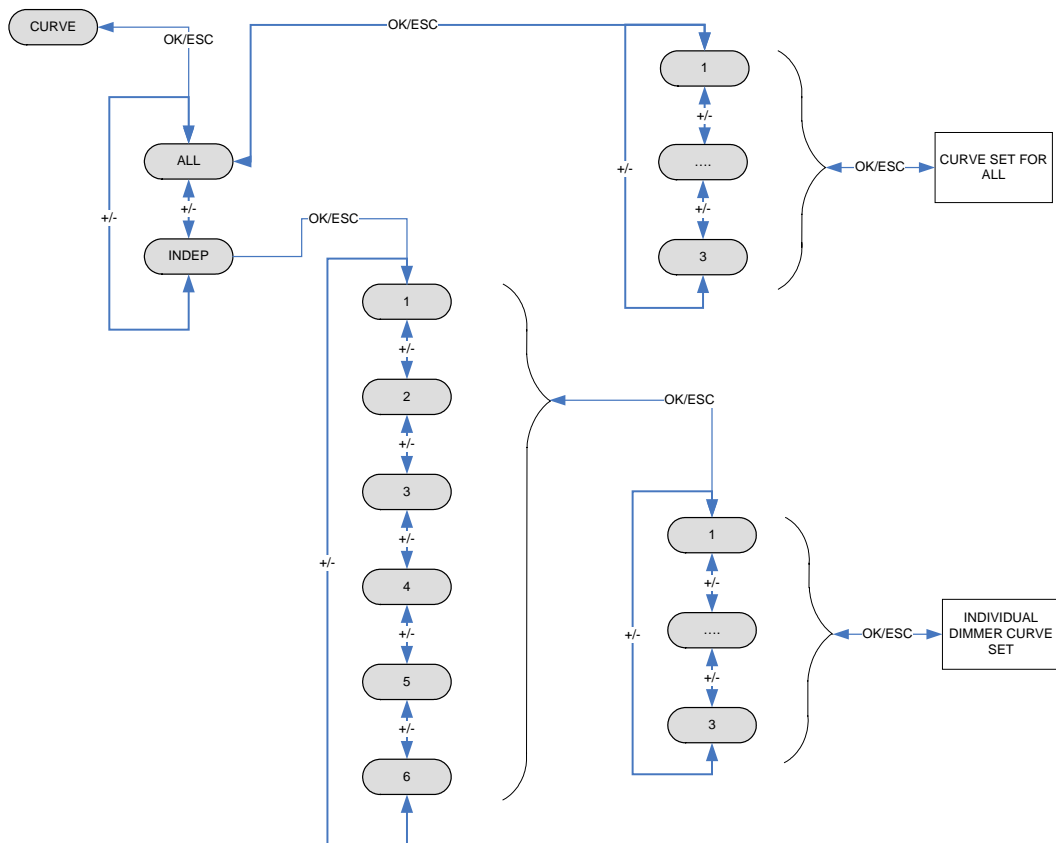

Minimum Level

This menu is to set the minimum output level of all or selected dimmers. Press the **OK** key once to confirm and use the **+** and **-** keys to select either the “Minimum level All” menu for all dimmers or “Minimum level Independent” menu for a single dimmer.

Set Minimum Level for all

When in the “Minimum level All” menu, press the **OK** key once, the minimum level will be displayed as a percentage. Use the **+** and **-** keys to select the minimum level (0 to 30%) for all dimmers.

Set Minimum Level for Single Dimmer

When in the “Minimum level Independent” menu, press the **OK** key once, the dimmer Channel # is now displayed, Use the **+** and **-** keys to select the dimmer channel (1 – 6) to be set and then press the **OK** key again. Now the percentage min level will be displayed, Use the **+** and **-** keys to select the desired Min Level (0 – 30%). Repeat the above process until all channels are set.

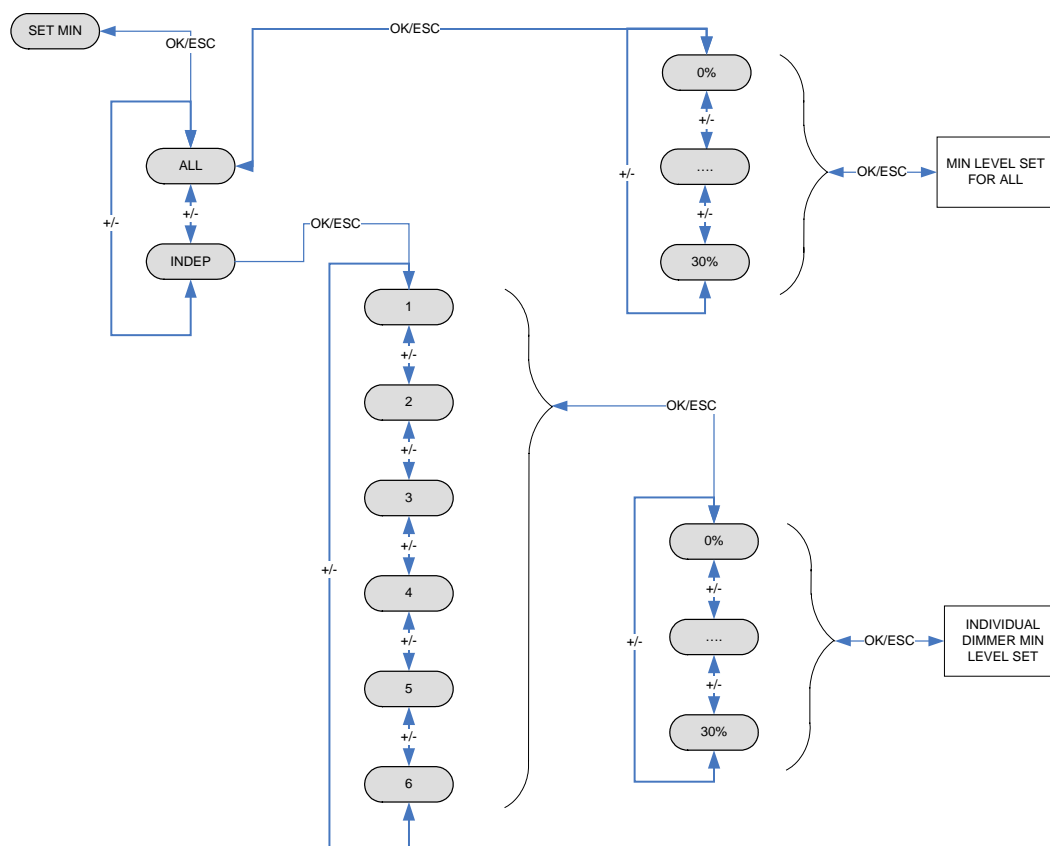

Maximum Level

This menu is to set the Maximum output level of all or selected dimmers. Press the **OK** key once to confirm and use the **+** and **-** keys to select either the “Maximum level All” menu for all dimmers or “Maximum level Independent” menu for a single dimmer.

Set Maximum Level for all

When in the “Maximum level All” menu, press the **OK** key once, the Maximum level will be displayed as a percentage. Use the **+** and **-** keys to select the Maximum level (70 to 100%) for all dimmers.

Set Maximum Level for Single Dimmer

When in the “Maximum level Independent” menu, press the **OK** key once, the dimmer Channel # is now displayed, Use the **+** and **-** keys to select the dimmer channel (1 – 6) to be set and then press the **OK** key again. Now the percentage Max level will be displayed, Use the **+** and **-** keys to select the desired Max Level (70 – 100%). Repeat the above process until all channels are set.

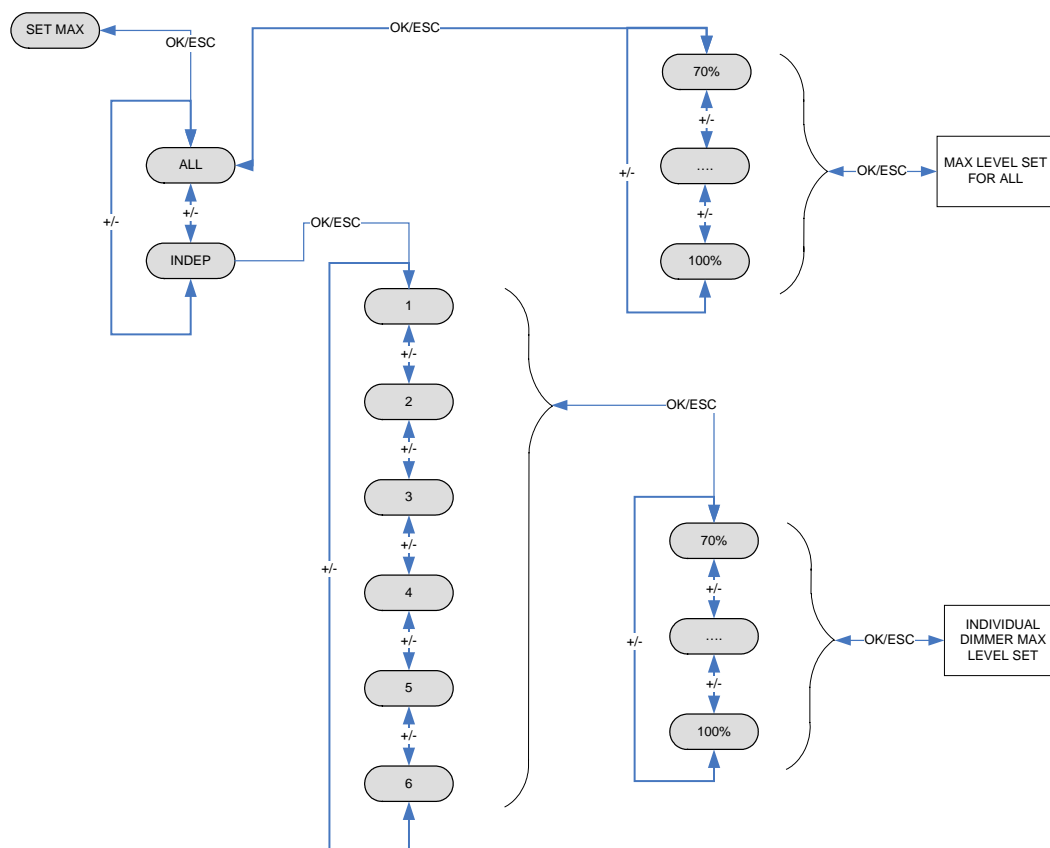

DMX Fail

This menu is to select what action the dimmer pack should follow on loss of DMX or DMX absence. The dimmer pack can be set as Last Hold, Delay or Preset when DMX fail. Press the **OK** key once to confirm and use the **+** and **-** keys to select either the “Last Hold” to hold the last lighting level, “Delay” to hold the lighting level for a certain period of delay time or “Preset” to hold the lighting level to a lighting preset.

Set Last Hold when DMX fail

When in the “Last Hold” menu, press the **OK** key once to select.

Set Delay when DMX fail

When in the “Delay” menu, press the **OK** key once, then use the **+** and **-** keys to select the number of second hold while DMX fail before black out. Press **OK** key once to confirm the number of second of delay.

Set Preset when DMX fail

When in the “Preset” menu, press the **OK** key once, then use the **+** and **-** keys to select the Preset # of lighting level while DMX fail. Press **OK** key once to confirm the Preset number.

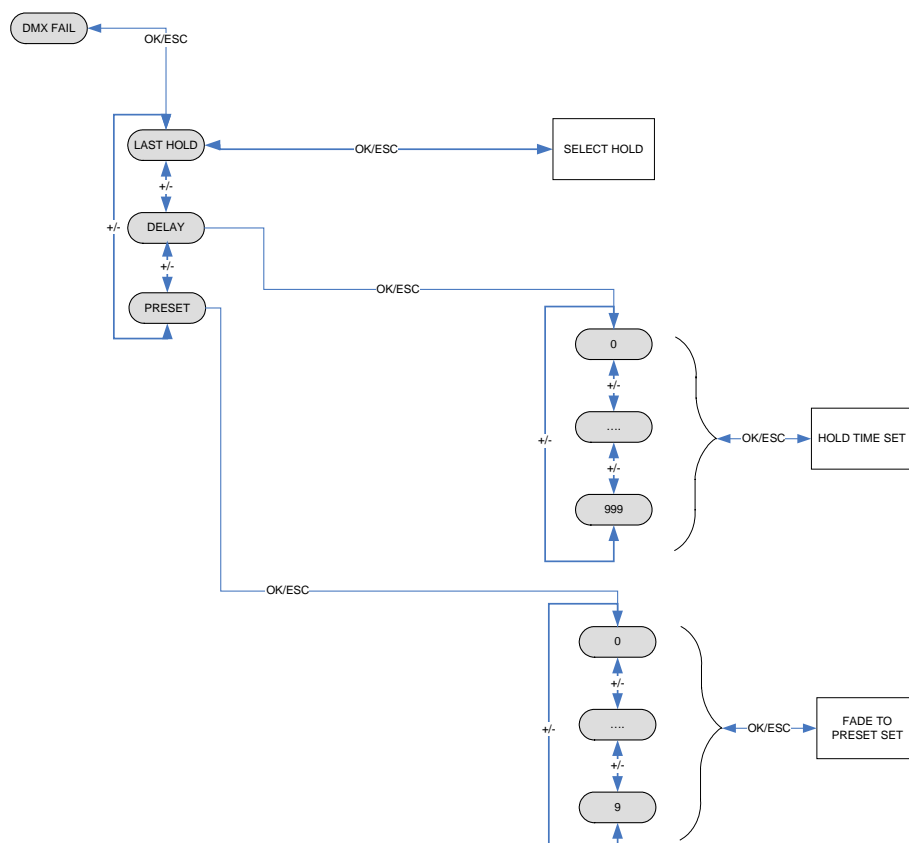

- END -

Berlin
Strand Lighting GmbH
Kurfürstendamm 70
10709 Berlin, Germany
Tel. +49-30-707-9510
Fax +49-30-707-95199

Hong Kong
Strand Lighting Asia LTD
20/F., Delta House
3 On Yiu Street
Shatin, N.T.
Hong Kong
Tel. +852-2757-3033
Fax +852-2757-1767

London
Strand Lighting Limited
Unit 3 Hammersmith Studios
Yeldham Road
Hammersmith
London, England W6 8JF
Tel. +44-20-8735-9790
Fax +44-20-8735-9799

Rome
Strand Lighting Italia
Via Delle Gardenie S.N.C.
Pontina Vecchia KM 33,400
00040 Pomezia
Italy
Tel. +39-0691-9631
Fax +39-0691-47138

